

MIAMI

Per te che abiti il mondo,  
c'è Miami, una cucina  
dall'anima cosmopolita.  
Eclettica e al passo con  
i tempi, si trasforma  
ogni volta, perché mille  
sono i modi di vivere!

MODERN

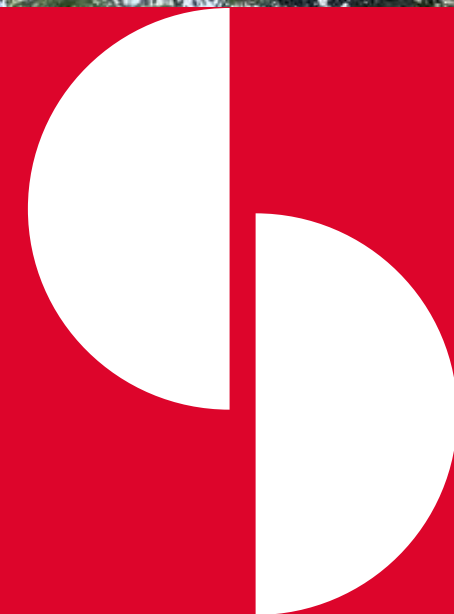

# MIAMI

SPAR cucine

For you, a citizen of  
the world, we have  
created Miami, a kitchen  
with a cosmopolitan  
soul. Eclectic and up  
to date, it is different in  
every installation, ideal  
for a thousand different  
lifestyles.



**SPAR**  
ARREDA

**Magnolia Due s.p.a.**

Via Guido Rossa, sc  
Talacchio di Colbordolo  
61022 Pesaro-Urbino (PU)

Tel (+39) 0721 48511  
Fax (+39) 0721 4851290

[sparcucine@spar.it](mailto:sparcucine@spar.it)

**SPAR**  
cucine

Dove cucina e living si incontrano, c'è Miami.

Giovane, dinamica, poliedrica: è Miami. Abbraccia con armonia la zona living e ci dialoga idealmente attraverso pareti attrezzate e moduli a vista che danno vita a uno spazio elegante e funzionale.

Miami: where kitchen and living area meet. Young, dynamic and multifaceted: Miami. It includes the living area in an attractive embrace, dialoguing with it through wall compositions and open modules that create elegant, functional design schemes.

# Design da vivere

Miami è una ma ha tante personalità. Perché è una collezione che si declina in diversi modelli, personalizzabili secondo il proprio gusto, abbinando molteplici materiali, finiture e elementi. Una cucina che è insieme bella e funzionale, progettata ergonomicamente per assecondare i gesti di chi si dedica alla preparazione dei cibi e la vive ogni giorno.

## Design for living

Miami is a single kitchen with many personalities. Because it is a collection subdivided into a number of models, which can be personalised to individual taste by combining a large choice of materials, finishes and units. A kitchen that is both functional and attractive, designed for convenience and to simplify the tasks of those who prepare food and spend time in it every day.



06



16



24



32



38



42



50



54



56



62



68



72

# Indovina chi entra in cucina

Prendiamo un uomo che non pensi solo al bilancio di fine anno. Immagiamone invece uno che non prova alcun imbarazzo ad entrare in cucina e ha bisogno di uno spazio non convenzionale, dove anche si mangia, si chiacchiera e magari si gioca con i propri figli. E' un ambiente funzionale, accogliente e in cui è piacevole stare, proprio come con Miami. L'anta in finitura frassino, con l'elegante maniglia a profilo nel colore moka è disponibile anche in finitura Brill.



## Guess who's coming into the kitchen

Imagine a man who thinks about things other than money. Who is happy to come into the kitchen and needs an unconventional space, where he can also eat, chat and perhaps play with his children.

A convenient, comfortable room, a pleasant space for living - just like Miami. The door in ash finish, with the elegant mocha handle strip, is also available in Brill finish.





# Poliedrica, Miami dialoga con il living.

Multi-faceted, Miami dialogues with the living area.



# Ora il Design aggiunge l'utilità all'estetica.

È la cucina, più di tutti, lo spazio in cui si sente l'esigenza di un'organizzazione strutturale e formale degli elementi. Miami distribuisce i volumi in maniera intelligente, mixando colonne e basi con anta a ribalta che facilita l'apertura e migliora l'operatività. Così anche dove lo spazio non è generoso, Miami concentra efficientemente le diverse aree dedicate alla preparazione e dà vita a un habitat che è al contempo ordinato e accogliente.

## Now Design adds practicality to style.

Of all the rooms in the home, the kitchen is the one where a carefully structured layout is most important. Miami distributes volumes with intelligence, mixing tall units and base units with flap doors, for easier opening and labour saving. So even where space is tight, Miami concentrates the various preparation areas efficiently, creating a habitat that is both neat and comfortable.

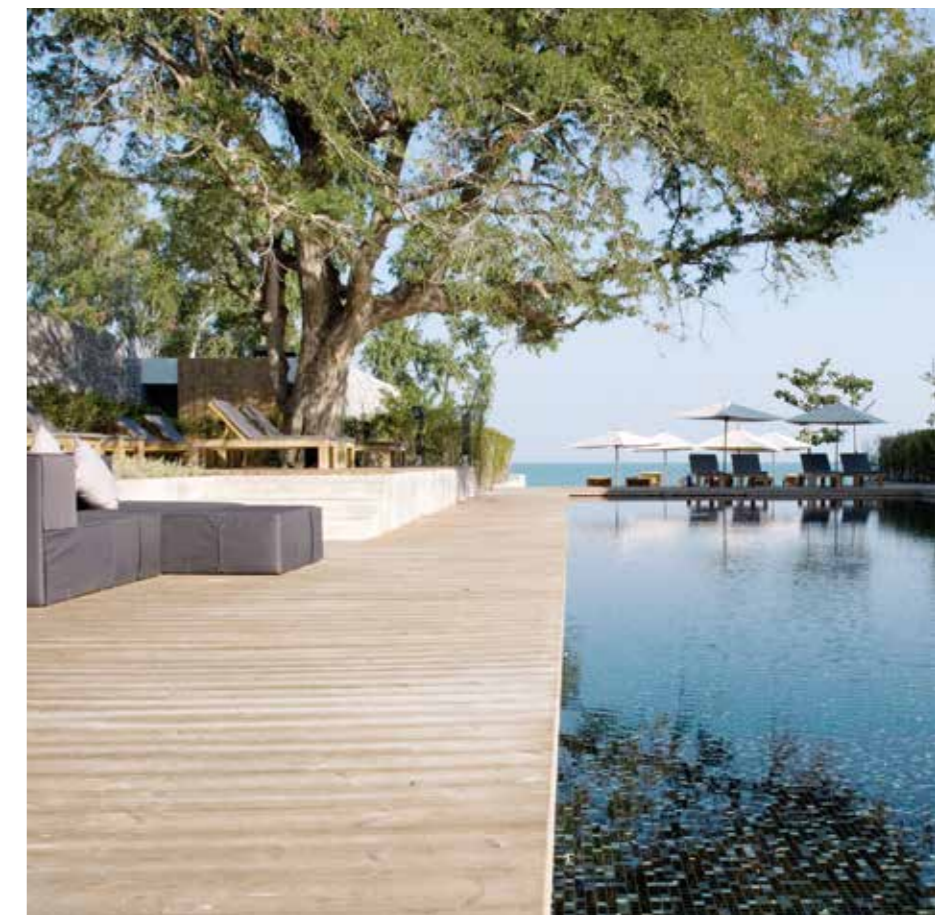



# L'isola che c'è.

Miami è una cucina dal design internazionale, dove i mobili hanno una duplice funzione vale a dire contenitiva ed estetica ma soprattutto si arricchiscono della personalità di chi li sceglie.

Così l'isola centrale, che concentra le aree del lavaggio e della cottura e insieme amplia il piano di lavoro, è anche il trait d'union tra cucina e living, perfettamente in linea con gli stili di vita più attuali.

## An island in the stream.

Miami is a kitchen designed on international principles, where the units serve a dual purpose - storage and style - and above all take on the personality of their owner. The central island, which both contains the washing and cooking areas and expands the work surface available, is also the link between the kitchen and living areas, in line with the very latest lifestyles.



# Componibilità evoluta



Vivere easily, tra il desiderio di rifugiarsi all'interno e quello di mostrarsi all'esterno. Il linguaggio progettuale si rinnova con una composizione dinamica e giovane che interpreta appieno le potenzialità espressive dello spazio.

Di fronte al sistema di grandi colonne che svolgono la funzione contenitiva, si snoda una serie di elementi caratterizzati da un'anta dall'affascinante matericità che trasferisce all'ambiente un grande calore.

## State-of-the-art modularity

Living easily, enjoying an intimate refuge yet also presenting a fine face to the world. Design language is renewed in this young, dynamic composition that interprets the space's expressive potential to the full. Opposite the system of large tall units that provide plenty of storage, a series of units featuring a door of great tactile appeal give the room immense warmth.

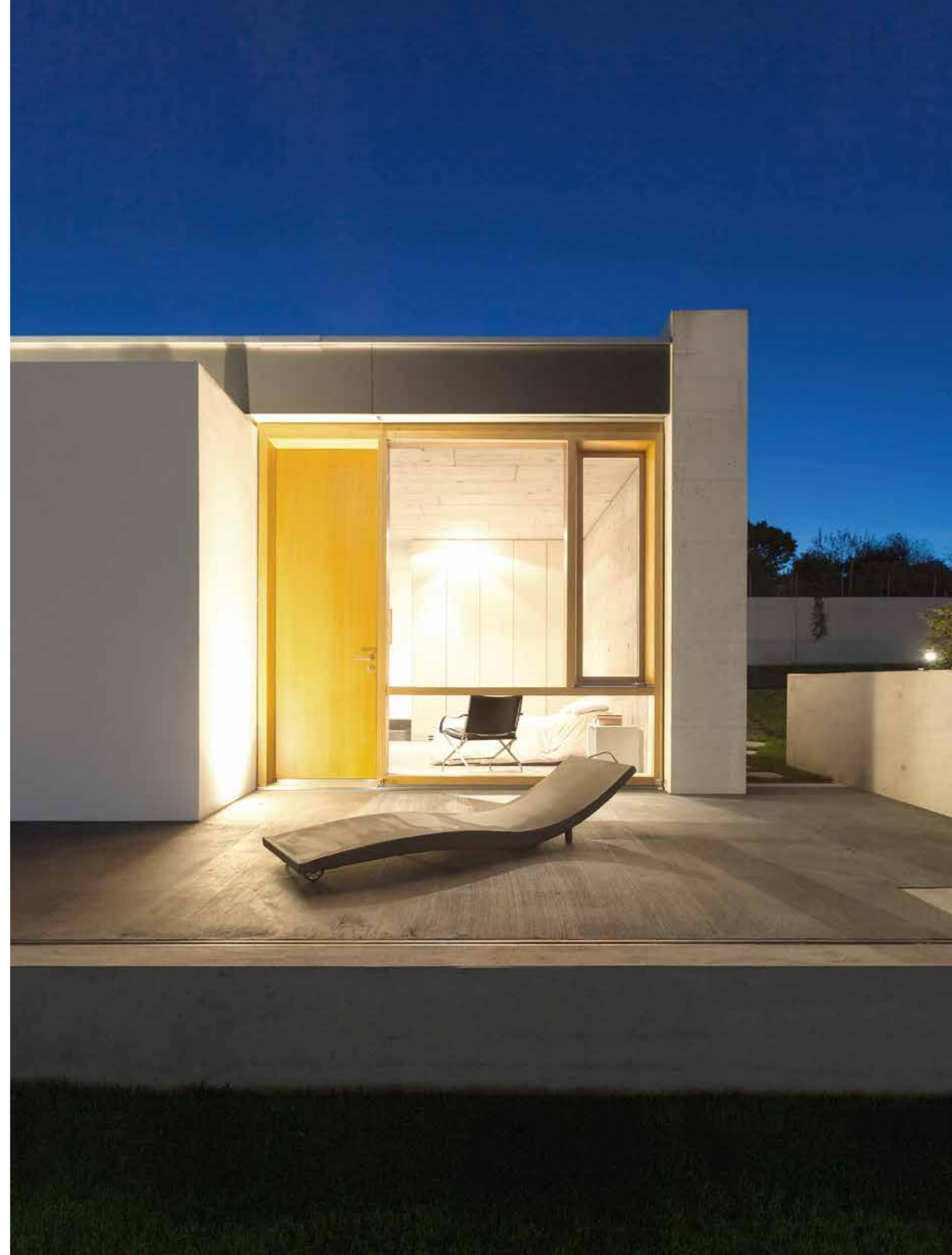



Prospettive che  
allargano gli orizzonti  
Horizon-widening perspectives

# In primo piano

Ricerca l'essenzialità delle linee non significa rinunciare alla funzionalità né all'estetica. Ecco che il piano, perfetto nei volumi e con finitura Quercia si armonizza e dà carattere al resto della composizione.

## Highlights

Simplicity of line can be achieved without sacrificing style or convenience. This worktop, with its immaculate forms and Oak finish, blends with and gives character to the rest of the composition.



# Raffinato incontro di spessori e volumi

Una composizione articolata ottenuta accostando pensili alti con basi che si sviluppano orizzontalmente, elementi chiusi alla libreria a giorno che divide il cooking dal living. Una geometria versatile che si esprime anche con l'accostamento di finiture diverse: il piano, dallo spessore di 6 cm, è valorizzato da una superficie con finitura Quercia e si sovrappone alla base con finitura Cemento come l'anta inclinata del pensile.

## Sophisticated mix of forms and thicknesses

A complex composition that combines tall wall units with wide base units, and enclosed units with the open bookcase that divides the cooking and living areas. The versatility of form is matched by the mixing of different finishes: the worktop, 6 cm thick, has an exquisite Oak finish and stands above a base unit with Concrete finish, also used on the wall unit with its slanted door.



# Spazi multifunzionali



Una casa da mostrare come un abito speciale ha bisogno di una cucina che sia un luogo di incontro, di relazione sociale per stare in relax con pochi amici ma capace anche di accogliere un party. Una cucina aperta, capace di interagire con il living senza mai rischiare cadute di stile. Miami esplora ora questa area di gusto, pensata per un pubblico giovane e fashion, sempre aperto al cambiamento.

## Multipurpose spaces

A home to be shown off like a special dress needs a kitchen that is also a meeting-place, a location for socialisation, whether relaxing with a few friends or hosting a full-scale party. An open kitchen, capable of interacting with the living area without ever lowering its tone. Miami now explores this taste in interior design, ideal for the young, fashionable user, always open to change.





# Equilibrio ergonomico

Tecnologia, innovazione, ergonomia per una cucina dalla forte identità che mixa linee rette con quelle curve. Il progetto, improntato alla flessibilità, divide l'area operativa dall'isola centrale con un piano caratterizzato dalla finitura cemento, così permette a più persone di fruire contemporaneamente di Miami.

## Labour-saving balance

Technology, innovation and ergonomics combine in a kitchen with a strong identity that mixes straight and curved lines. The highly flexible layout divides the working area from the central island with a concrete-finish worktop, allowing several people to use Miami at once.



# Internazionale, essenziale



E la cucina diventa un modo per essere visibile, riconosciuto, ma sempre in maniera elegante, secondo un mood che del minimalismo sembra aver preso la propensione a ripulire la forma degli arredi per arrivare a un'essenzialità che può vivere ovunque nel mondo. Proprio come il pubblico che la sceglie: fantasioso, pragmatico, libero e soprattutto capace di star bene ovunque. Ecco allora che lo spazio diventa di volta in volta una "grande piazza", un luogo intimo o semplicemente un ambiente capace di ospitare la vita quotidiana.

## International, essential

The kitchen becomes a way of gaining visibility and recognition, but always with impeccable elegance, in a mood that seems to have borrowed minimalism's habit of stripping down the forms of furniture to a simplicity that can look good anywhere in the world. Just like the people who choose it: imaginative, pragmatic, free and above all able to be happy anywhere. So this interior has multiple identities: an open meeting-place, an intimate living space or just a room for everyday life.





# Variazioni sul tema del neutro

Variations on a neutral theme

# Linee essenziali, massima funzionalità

A misura di ogni giorno con una cucina che incontra il sogno di un progetto capace d'integrare le funzioni tradizionali con quelle contemporanee. Miami interpreta il cambiamento, mettendo in mostra il suo mood più informale. Di fronte all'area operativa, un sistema di colonne e spazi a giorno, raccordati da un grande piano di lavoro, creano un habitat da vivere senza condizionamenti.

## Simple lines, maximum convenience

Styled for daily life, a kitchen that fulfils the dream of combining both traditional and contemporary functions. Miami interprets change by revealing its most casual mood. Facing the working area is a system of tall units and open spaces, connected by a large worktop, creating a habitat where life can be lived in freedom.





# Soluzioni innovative per Miami

Miami asseconda nuovi ritmi di vita quotidiana e soddisfa desideri di personalizzazione. Una cucina lineare che vanta contenuti e funzionalità perfette per trasformarsi in uno spazio vivibilissimo. Miami incontra gusti diversi che interpreta con eleganza: pareti attrezzate, colonne, penisole in un'ampia gamma di colori permettono di esprimere la propria idea di interni.

## Innovative solutions for Miami

Miami supports the new rhythms of daily life and delights those wishing to personalise their kitchen. A simple kitchen with contents and functions perfect for transforming into a fantastic living space. Miami satisfies a variety of tastes, interpreting them with elegance: wall compositions, tall units and peninsulas in a wide range of colours allow everyone to express their own idea of interior design.



# Ispirazione Urbana



Chi la sceglie ama la vita urbana, vivace, socievole, stimolante. Ama le città, piene di contrasti creativi, dove tutto e il suo contrario può accadere. Miami è un mood giovane, è il dinamismo più attuale, è l'immaginazione di chi la sceglie per abitarla in un ex loft industriale, in una villetta elegante o all'ultimo piano di un grattacielo.

## Urban inspiration

Those who choose this kitchen love urban life: lively, sociable, stimulating. They love cities, full of creative contrasts, where everything and its opposite may happen. Miami is a young mood, the most contemporary dynamism, the imagination of those who choose it to furnish a reclaimed industrial loft, an elegant terraced house or the top floor of a skyscraper.





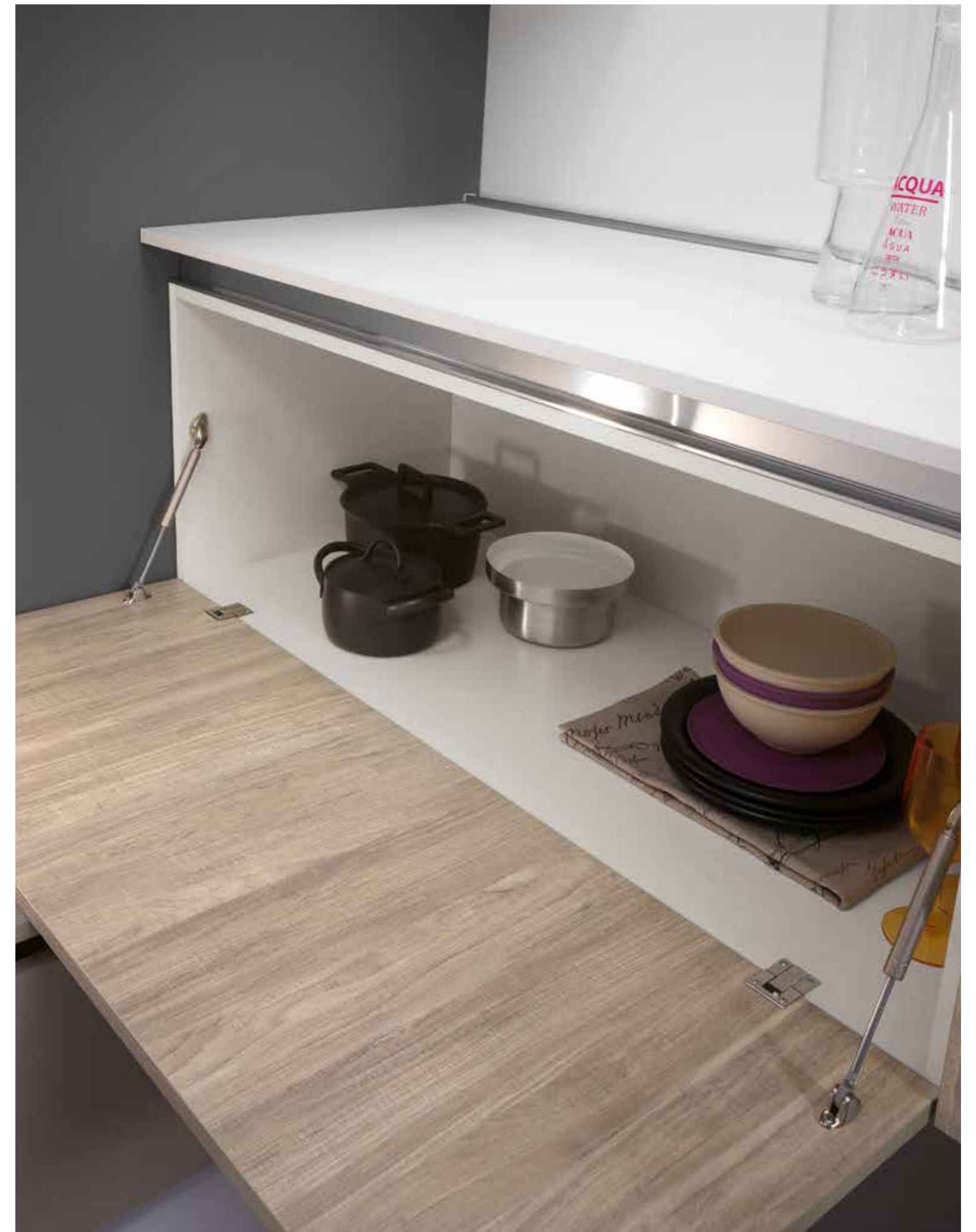

# Nuova geometria compositiva

Un modulo unico che si ripete secondo uno schema libero che alleggerisce la percezione d'ingombro delle cucine tradizionali: elementi e basi a giorno contaminano lo spazio domestico e assieme a finiture e materiali nuovi impreziosiscono il design con cromatismi ed effetti visivi originali.

## New compositional geometries

A single module, repeated in a freely chosen layout that lightens the perceived bulk of a traditional kitchen: open elements and base units contaminate the home, and together with new finishes and materials they create an exquisite design with original colours and visual effects.



# Libera scelta degli spazi interni

Nessuno ama cercare qualcosa a lungo e in cucina tutto deve essere immediatamente visibile. Ecco perché Miami è attrezzabile anche con un sistema funzionale di colonne estraibili alte 204 cm in cui lo spazio è perfettamente sfruttato.

## Free choice of interiors

No-one likes having to hunt for things and in the kitchen everything must be visible at a glance. So Miami can also be fitted with a convenient system of pull-out tall units 204 cm high, allowing full use of all the space available.







# La curva esprime modernità

Perché la vita non è mai una linea retta ma un progetto in continua evoluzione. E' quindi importante essere pronti a captare il cambiamento, a cogliere segnali talvolta impercettibili. Un concept che si ritrova anche in Miami che ora modifica lo spazio domestico attraverso una progettazione che non contempla solo elementi rigorosamente lineari ma introduce anche elementi dalla geometria sinuosa.



## The curve, expression of modernity

Because life is a continually evolving project, and never a straight line. So it is important to be ready to respond to changes, picking up signs that may be imperceptible. A concept also found in Miami, which now modifies domestic space through design that includes not only severely straight elements but also units with sinuous curves.







# La luce che viene da fuori



Ricerca nella vita di ogni giorno momenti di condivisione. Un design privo di angoli vivi, dove la vita si incontra, senza scontrarsi. Spazi avvolgenti in cui ritrovarsi e dare espressione alle proprie passioni. Nasce la necessità di una cucina dal disegno più morbido in cui il freddo minimalismo viene addolcito dall'inserimento di linee curve. Proprio come in questa composizione che sembra accogliere tutti con un grande abbraccio.

## The light from outside

Trying to share some time every day. A design without sharp corners, where lives can meet without colliding. Comfortable spaces, for meeting to express common passions. All this requires a kitchen with a gentler design, where cold minimalism is softened by the inclusion of curved lines. As in this composition, which seems to welcome all comers in a warm embrace.

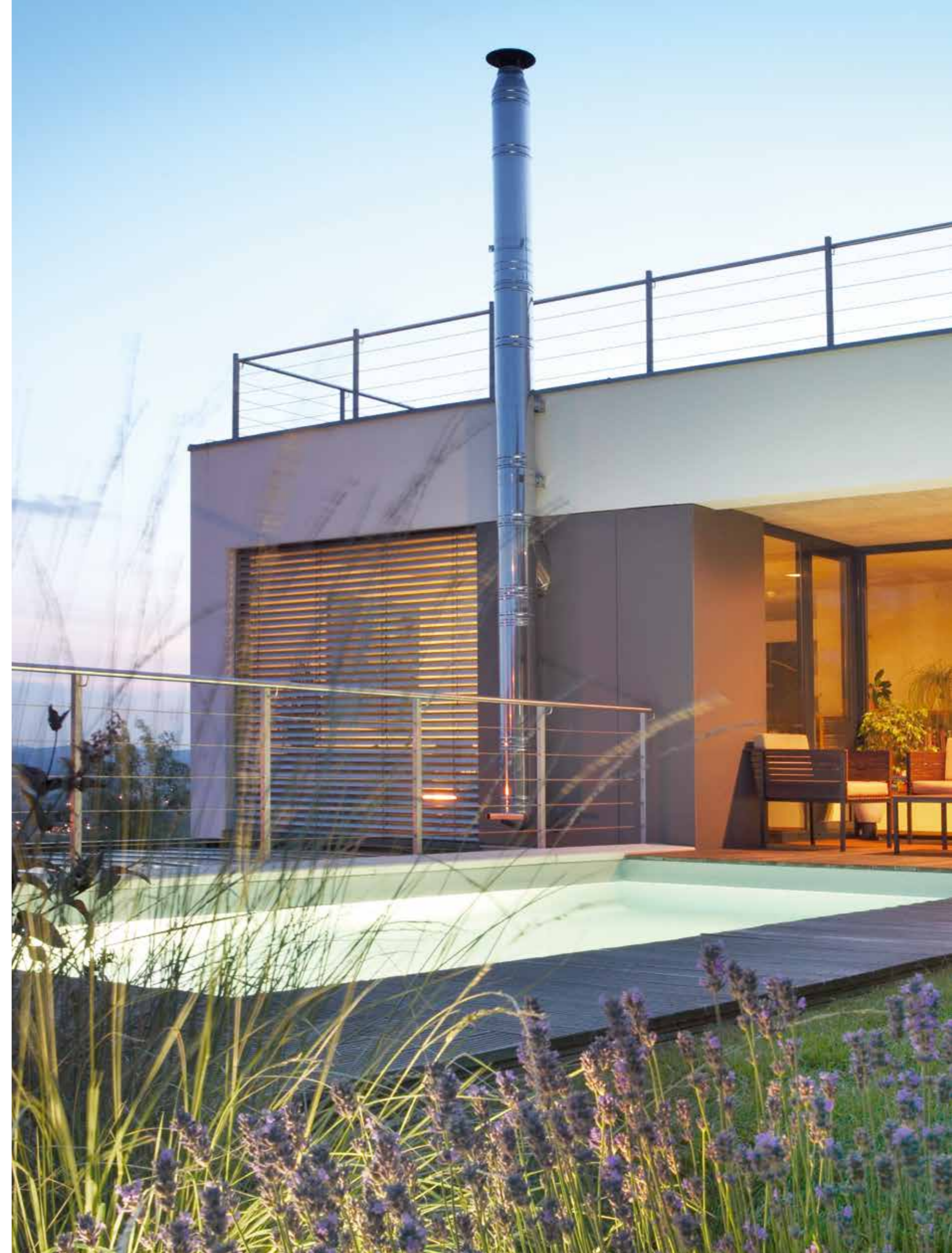



Neutro sofisticato

Sophisticated neutral

# Ottimizzare lo spazio è ottimizzare il tempo

Progettare consapevolmente non significa soltanto pensare ad un design evoluto ma alle più flessibili soluzioni di contenimento siano essi i cestoni attrezzati sotto il lavello, siano i contenitori completamente estraibili anche negli angoli, siano i cassetti del blocco Round, un blocco multifunzione largo 120 cm che contiene dei capienti cestoni da 90 cm.

## Optimising space means optimising time

Intelligent design means not only complying with the latest styles but also providing the most flexible storage solutions, whether fitted baskets underneath the sink, fully pull-out containers even in the corners, or the drawers of the Round block, a multipurpose block 120 cm wide containing roomy 90 cm baskets.



# Voglia di colore

Accostamenti cromatici tutt'altro che neutri definiscono i nuclei attivi del lavoro in cucina, la zona lavaggio e la cottura con soluzioni ergonomiche che disegnano spazi ricchi di funzionalità all'insegna di un nuovo concetto di cucina.

## Colour is king

Vibrant colour combinations define the kitchen's working areas, the washing and cooking zones, with labour-saving solutions that create function-packed spaces for a new-concept kitchen.







Informazioni Tecniche  
Technical Information

PROPOSAL 01



PAG. 08 - 09

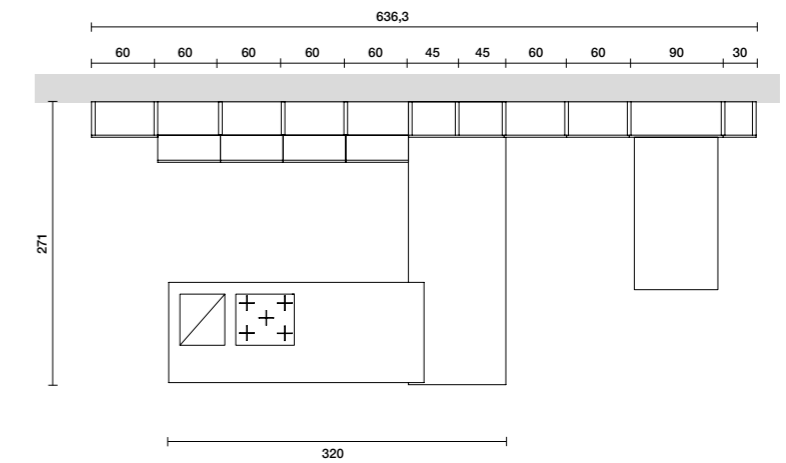

Finitura - Finish  
Frassino S122  
Laccato cenere opaco

Top - Top  
Tavolato ruggine 4492 sp. 4 cm ABS

Maniglia - Handle  
Profilo Moka

PROPOSAL 02



PAG. 18 - 19

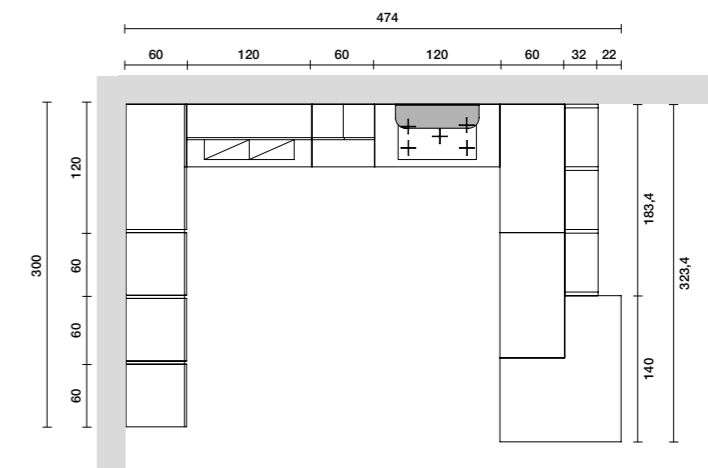

Finitura - Finish  
Quercia 0788  
Cemento 5556  
Laccato RAL 7022 opaco

Top - Top  
Stone 545 sp. 2 ABS  
Quercia 0788 sp. 6

Maniglia - Handle  
Gola RAL 7022 opaco

PROPOSAL 03



PAG. 26 - 27

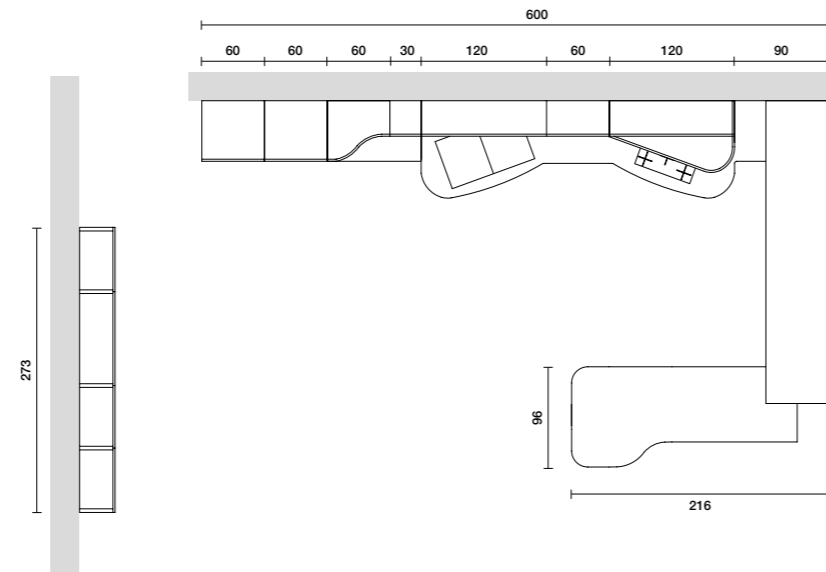

Finitura - Finish  
Vintage  
Laccato castagna lucido

Top - Top  
Stone 545 sp. 4 ABS  
Cemento 6066 sp. 4 ABS

Maniglia - Handle  
U5340 cromo

PROPOSAL 05



PAG. 38 - 39

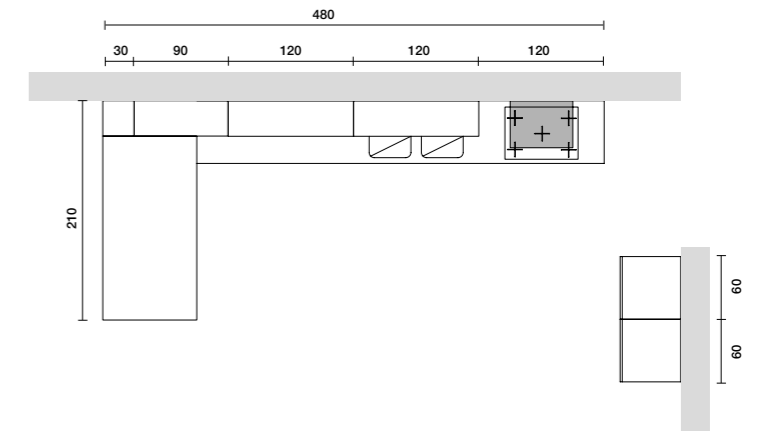

Finitura - Finish  
Tranché bianco  
Tranché grigio  
Laccato RAL 5014 opaco

Top - Top  
Grigio 3326 Mika sp. 4 ABS

Maniglia - Handle  
387 B satinata

PROPOSAL 04



PAG. 34 - 35

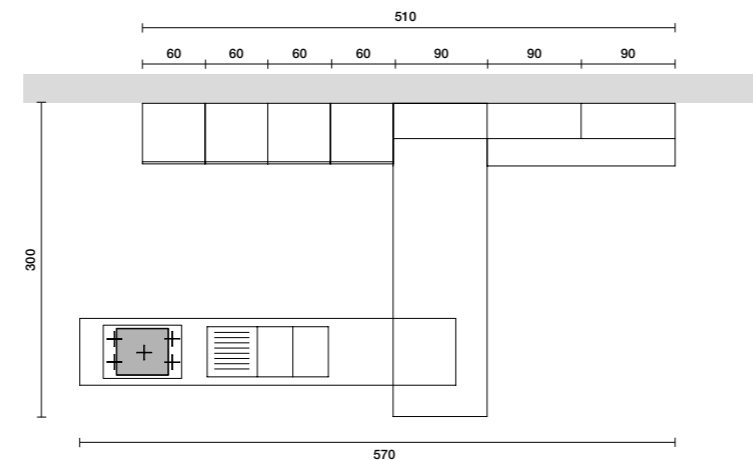

Finitura - Finish  
Rovere grigio  
Laccato bianco opaco  
Laccato RAL 7022 opaco

Top - Top  
Marmo di Carrara sp. 3  
Sabbia 3510 sp. 4 ABS

Maniglia - Handle  
U5340

PROPOSAL 06



PAG. 44 - 45

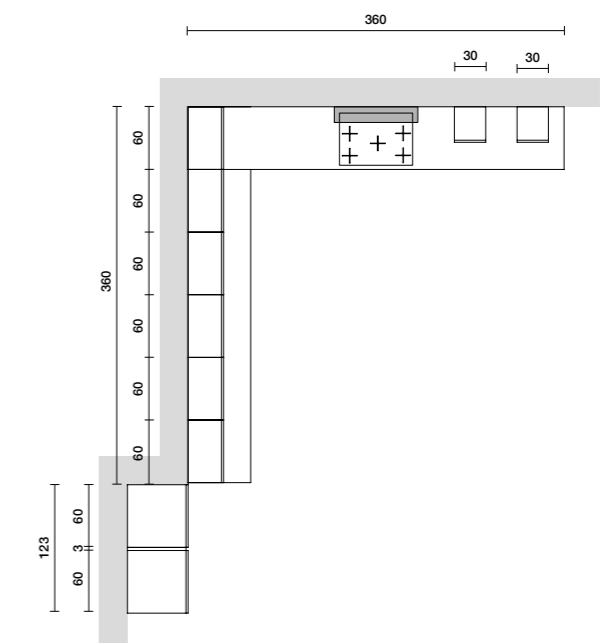

Finitura - Finish  
Noce chiaro  
Laccato castagna opaco

Top - Top  
Bianco Wraky sp. 2 ABS

Maniglia - Handle  
Gola Brill laccata RAL 7022 opaco

PROPOSAL 07



PAG. 52 - 53

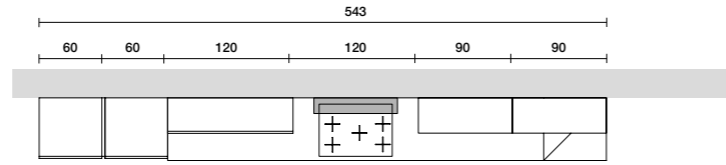

Finitura - Finish  
Tranché grigio  
Laccato RAL 5014 opaco

Top - Top  
Quarzo Zeus sp. 2

Maniglia - Handle  
Gola Brill

PROPOSAL 09



PAG. 58 - 59

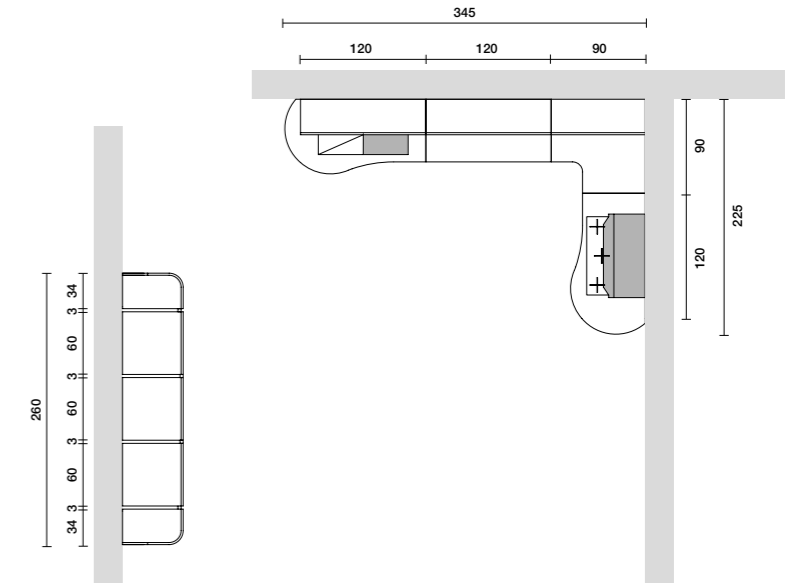

Finitura - Finish  
Laccato bianco opaco

Top - Top  
Bianco Wraky sp. 2 ABS

Maniglia - Handle  
Gola bianca

PROPOSAL 08



PAG. 54 - 55

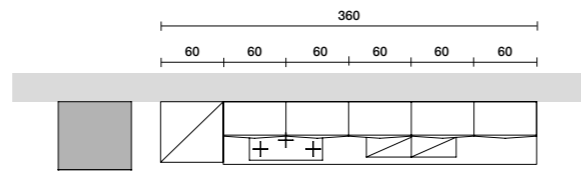

Finitura - Finish  
Laccato bianco opaco  
Laccato tortora opaco

Top - Top  
Bianco sp. 2 ABS

Maniglia - Handle  
Gola bianca

PROPOSAL 10



PAG. 64 - 65

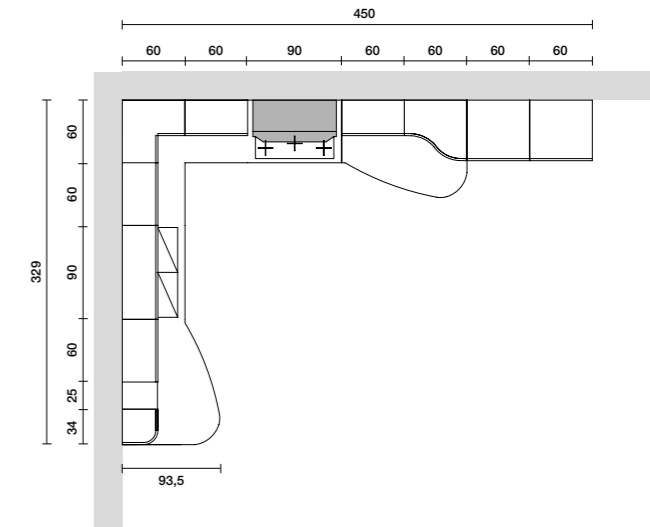

Finitura - Finish  
Laccato tortora opaco

Top - Top  
Eloro sp. 4 ABS

Maniglia - Handle  
385 B satinata

PROPOSAL 11



PAG. 70 - 71

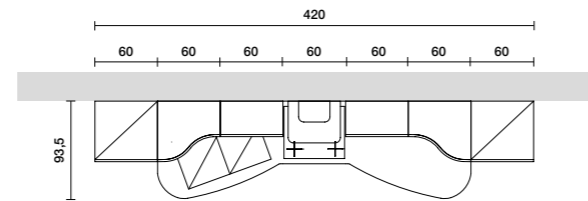

Finitura - Finish  
Clay  
Beton

Top - Top  
Grigio 3326 Mika sp. 4 ABS

Maniglia - Handle  
U5340 cromo

MANIGLIE - HANDLES



mod.U5340 (int.160)  
finitura cromata - chrome finish



mod.U5340 (int.320)  
finitura cromata - chrome finish



mod.387B (int.160)  
finitura satinata - satin finish



mod.12932 (int.160)  
finitura cromata - chrome finish



mod.U12943 (int.160)  
finitura cromata - chrome finish



mod.U12943 (int.320)  
finitura cromata - chrome finish



mod.U12909 (int.96)  
finitura cromata - chrome finish



mod.U12909 (int.160)  
finitura cromata - chrome finish



mod.404 (int.160)  
finitura satinata - satin finish



mod.404 (int.320)  
finitura satinata - satin finish



mod.328 (int.160/192)  
finitura satinata - satin finish

PROPOSAL 12



PAG. 72 - 73

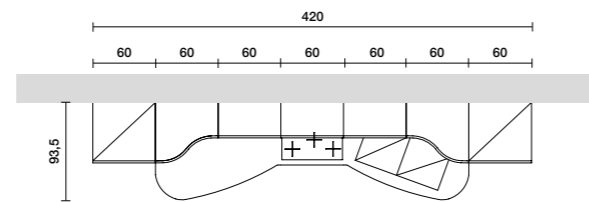

Finitura - Finish  
Laccato RAL 3001 lucido

Top - Top  
Basalto 3342 sp. 4 ABS

Maniglia - Handle  
U5340 cromo

Anta in sezione  
Door cross-section

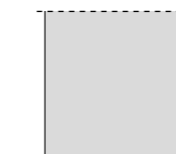

2 cm  
Scala 1:1

Anta Essenza:  
in melaminico sp.20 mm.  
bordo 4 lati con ABS in tinta.

Essenza Door:  
in melamine, thickness 20 mm.  
edged on all 4 sides with matching colour ABS.

Anta Laminata:  
In laminato HPL sp. 20 mm.  
bordo 4 lati con ABS in tinta.

Laminate Door:  
In HPL laminate, th. 20 mm, edged  
on 4 sides in ABS in matching colour

Anta Laccata:  
In melaminico sp. 20 mm.  
laccata opaco o lucido con vernice poliuretana.

Lacquered Door:  
In melamine, thickness 20 mm, matte  
or glossy lacquered with polyurethane varnish.

SISTEMA DI APERTURA - OPENING SYSTEMS

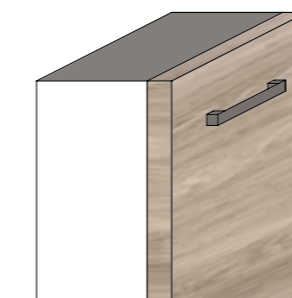

Maniglia  
Handle

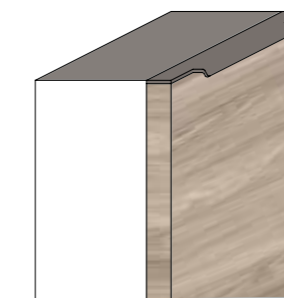

Maniglia Profilo  
Handle Profilo

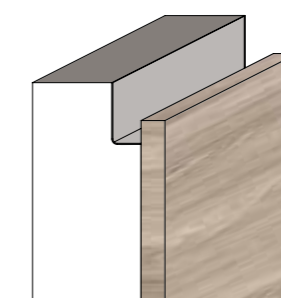

Life  
Life

FINITURE DISPONIBILI - AVAILABLE FINISHES

Essenza  
Essence



Tranchè bianco



Tranchè grigio



Olmo



Rovere marrone



Rovere grigio



Noce chiaro



Grey \*



Clay \*



Frassino 122



Vintage \*



Brown \*



Rovere \*



Beton \*

Laminati  
Laminates



Cemento 5556



Pietra



Quercia

Laccati  
Lacquered

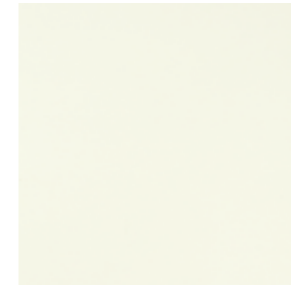

Bianco

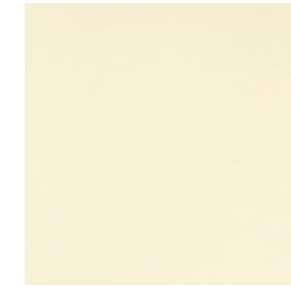

Avorio



Tortora \*\*



Nero



Viola 4001



Blu 5014



Grigio 7031



Blu 5020



Rosso \*\*



Giallo \*\*



Cappuccino \*\*



Uisone \*\*



Cenere \*\*



Castagna \*\*



Rosso 3001



Grigio 7043

\* Finiture disponibili per elementi Round  
Finishes available for Round units

\*\* Finiture compatibili con programma Spar giorno/notte  
Spar kitchen and dining/bedroom programme compatible finishes

 **SPAR**  
cucine